

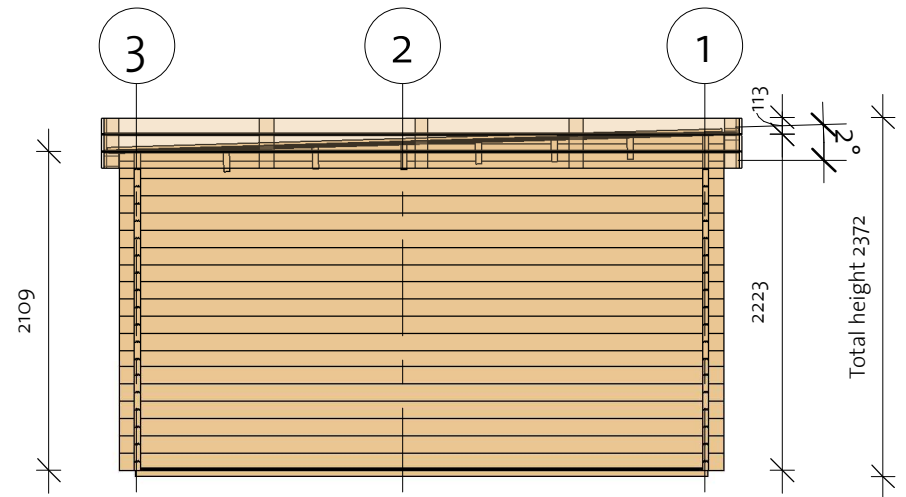

Miami 40 (480x380)

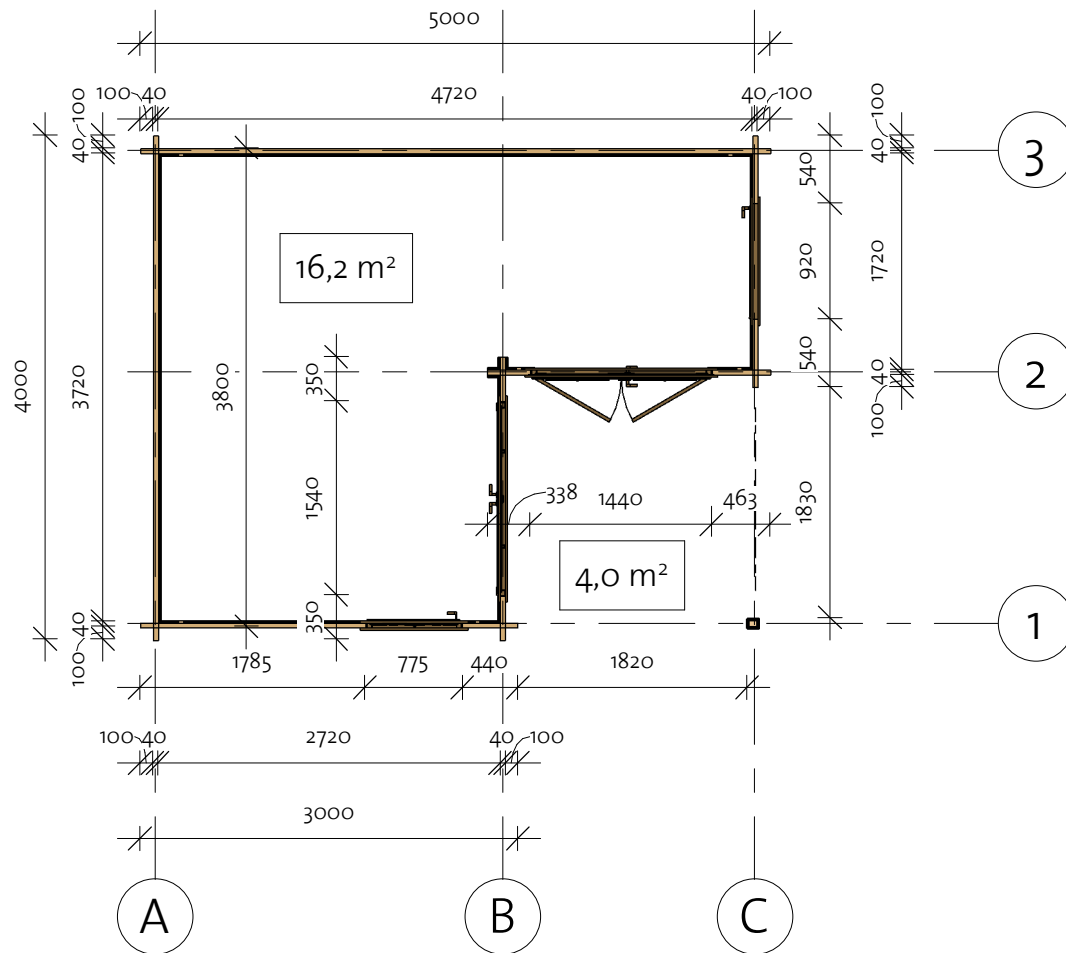
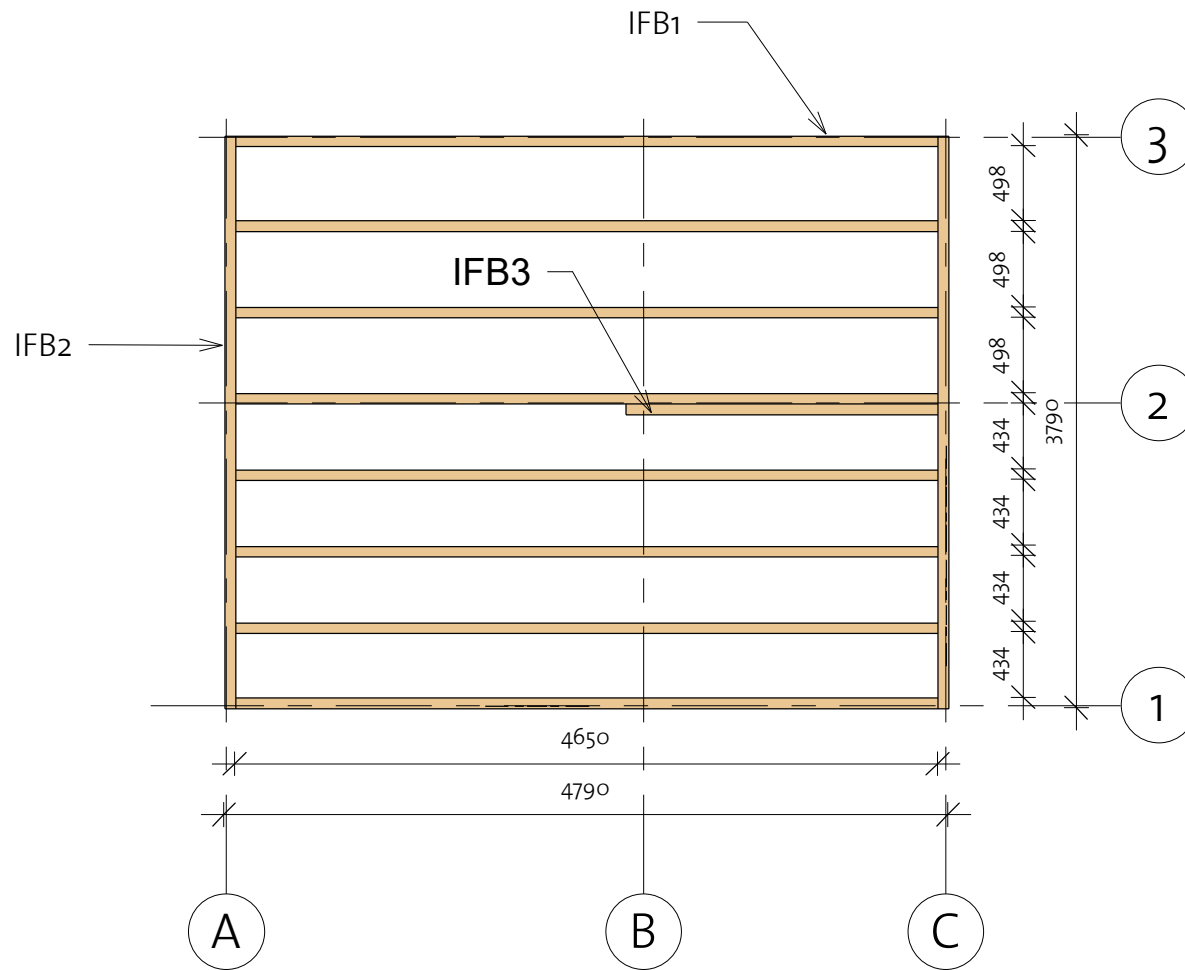

Miami 40 (480x380)

Foundation







Impregnated foundation beams				
Mark	Type	Profile	Count	Length
IFB1	IFB 70x40		8	4650
IFB2	IFB 70x40		2	3790
IFB3	IFB 70x40		1	2065

Miami 40 (480x380)

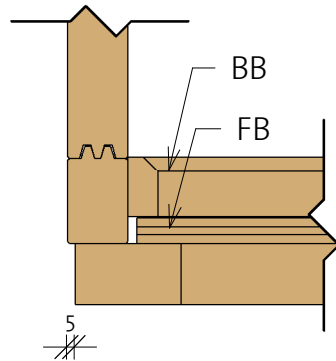
Floor Plan

① Baseboard



Floor Schedule				
Mark	Type	Profile	Count	Length
FB1	FB 17x114		18	1749
FB2	FB 17x114		26	3714
TB	TB 21x95		21	1995
BB	BB 20x40		4	4800

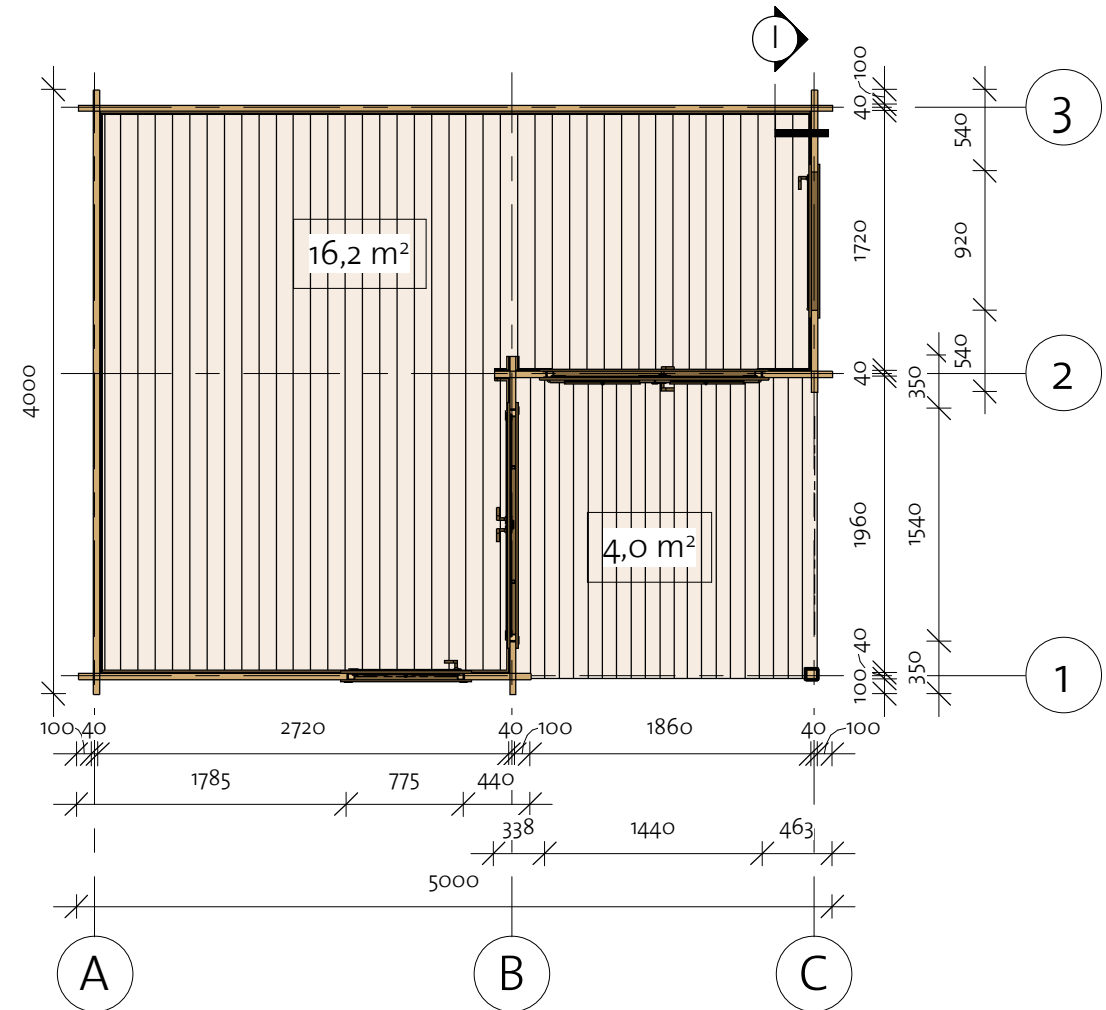

Miami 40 (480x380)

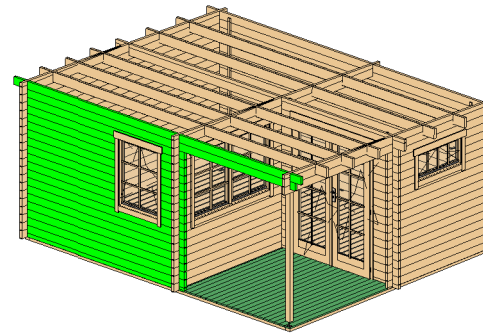

Wall 1



Wall 1			
Mark	Profile	Count	Cut Length

1BL-1	40X57	1	3000
1LG-1	40X114	8	440
1LG-2	40X114	8	1785
1LG-3	40X114	7	3000
1LG-4	40X114	1	5000
1LG-5	40X114	1	3000
1LG-6	40X114	1	3000
1TL-1	40X114	1	5200

Log Profile Wall 1	
Profile	Profile

40X57	
40X114	
40X114	

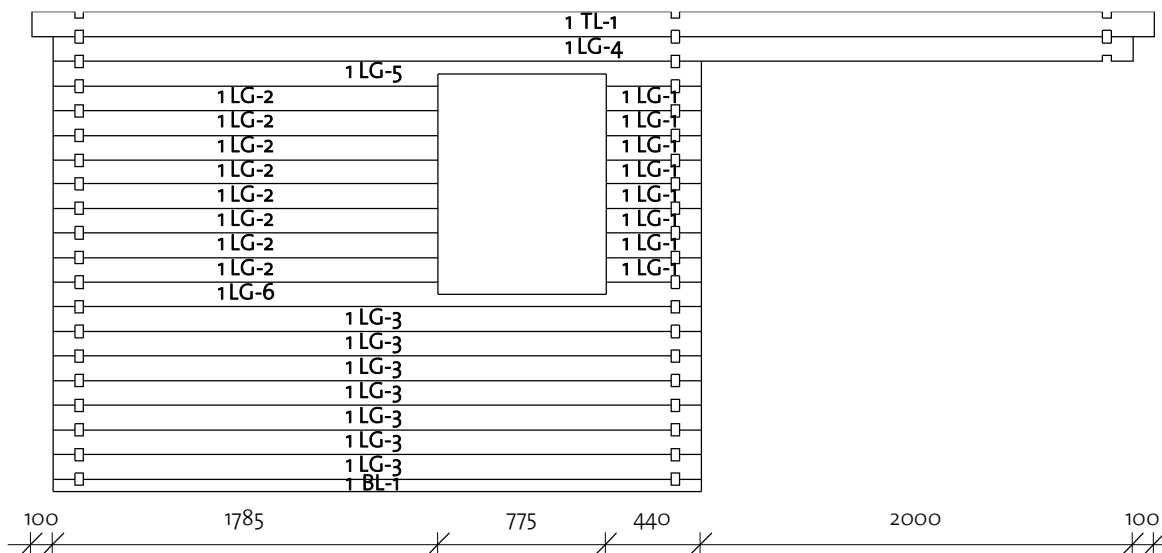

Miami 40 (480x380)

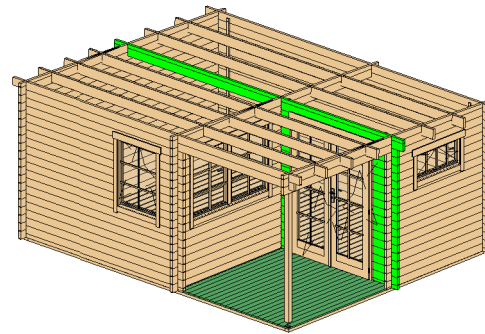

Wall 2



Wall 2			
Mark	Profile	Count	Cut Length

2BL-1	40X57	1	338
2BL-2	40X57	1	463
2LG-1	40X114	17	338
2LG-2	40X114	1	5200
2LG-3	40X114	17	463
2TL-1	40X53	1	5200

Log Profile Wall 2	
Profile	Profile

40X57	
40X114	
40X53	

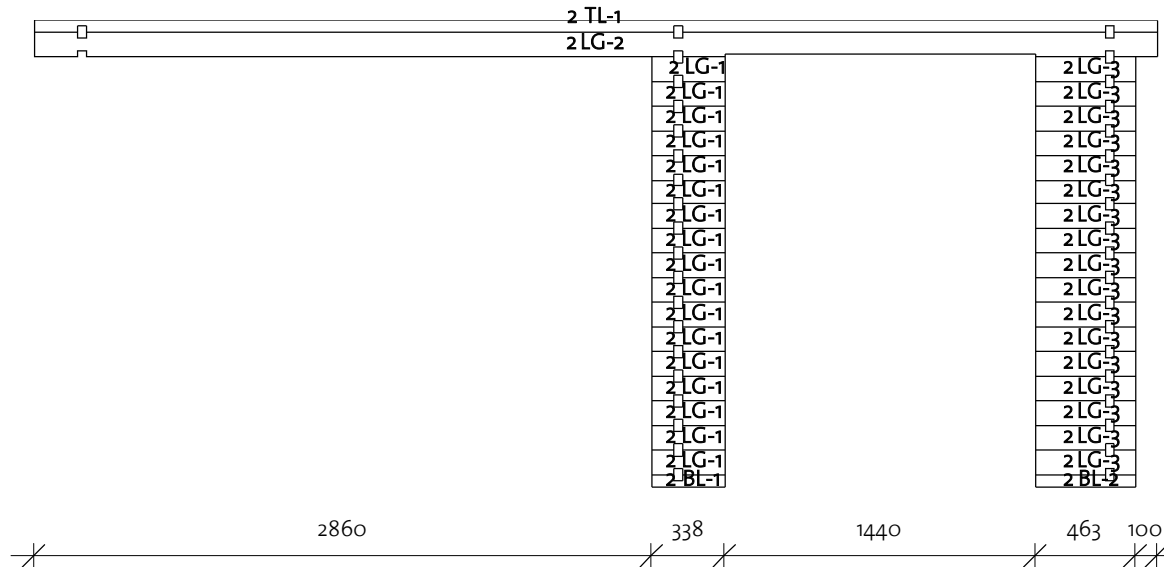

Miami 40 (480x380)

Wall 3

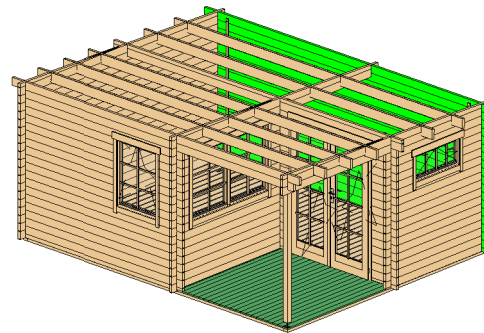

Wall 3			
Mark	Profile	Count	Cut Length

3BL-1	40x57	1	5000
3LG-1	40x114	16	5000
3LG-2	40x114	1	5000
3TL-1	40x114	1	5200

Log Profile Wall 3	
Profile	Profile

40x57	
40x114	
40x114	

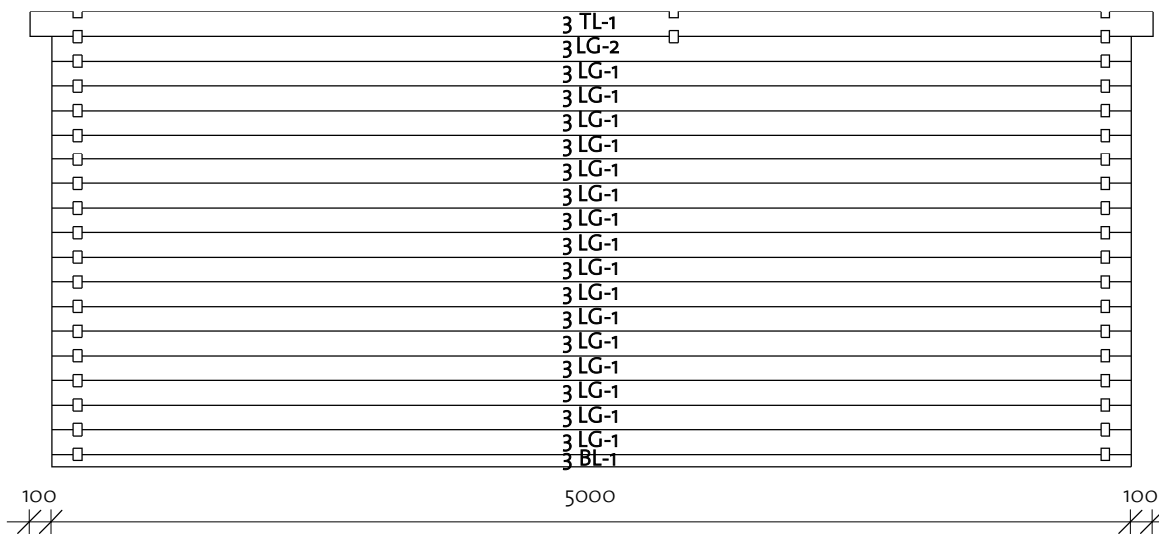

Miami 40 (480x380)

Wall A

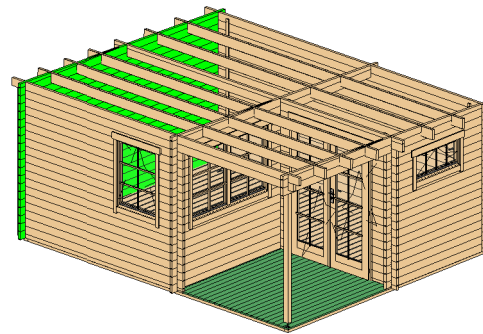

Wall A			
Mark	Profile	Count	Cut Length

ALG-1	40x114	17	4000
ALG-2*	40x114	1	4000
ALG-3*	40x114	1	4000
ALG-4*	40x114	1	1957

* Gable - delivered premounted

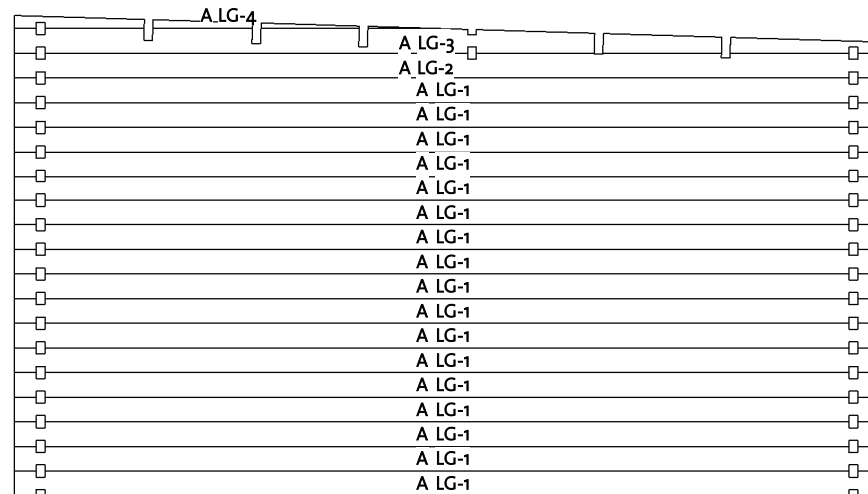

Log Profile Wall A	
Profile	Profile

40x114	
--------	--

Miami 40 (480x380)

Wall B

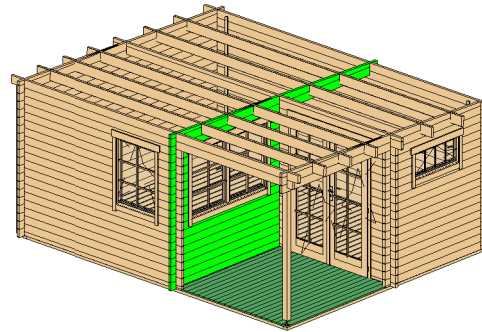

Wall B			
Mark	Profile	Count	Cut Length

BLG-1	40X114	18	350
BLG-2*	40X114	1	1957
BLG-3	40X114	8	2240
BLG-4*	40X114	1	4000
BLG-5*	40X114	1	4000

* Gable - delivered premounted

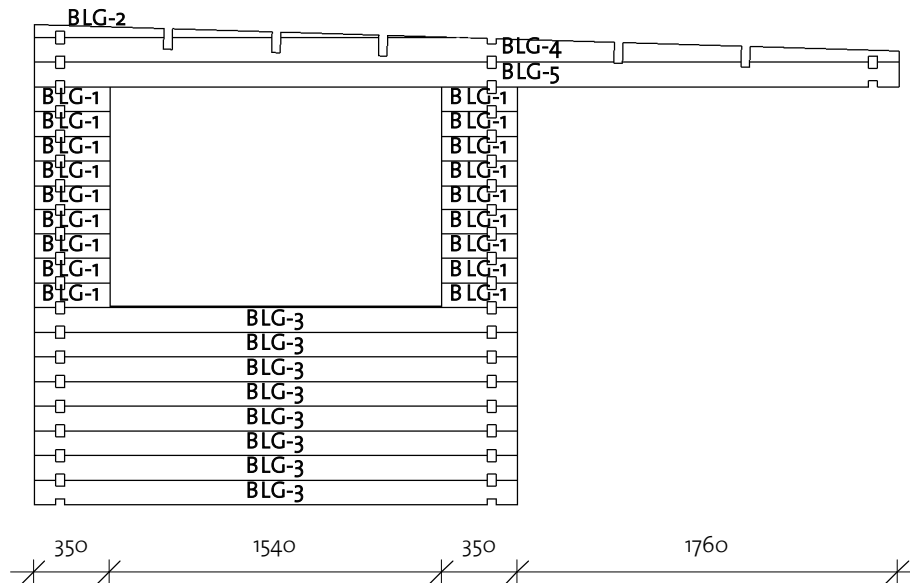

Log Profile Wall B	
Profile	Profile

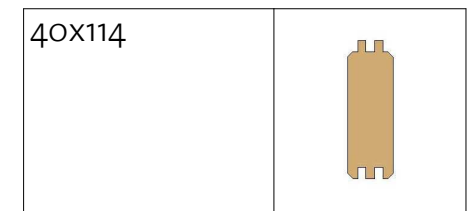

Miami 40 (480x380)

Wall C

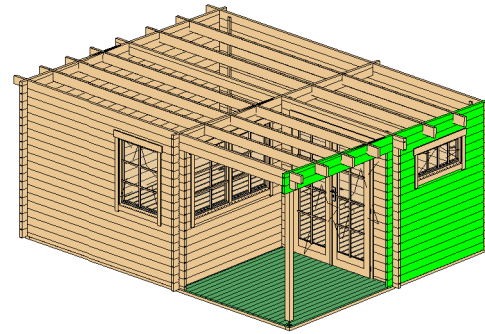

Wall C			
Mark	Profile	Count	Cut Length

CLG-1	40x114	8	540
CLG-2*	40x114	1	1957
CLG-3	40x114	13	2000
CLG-4*	40x114	1	4000
CLG-5*	40x114	1	4000

* Gable - delivered premounted

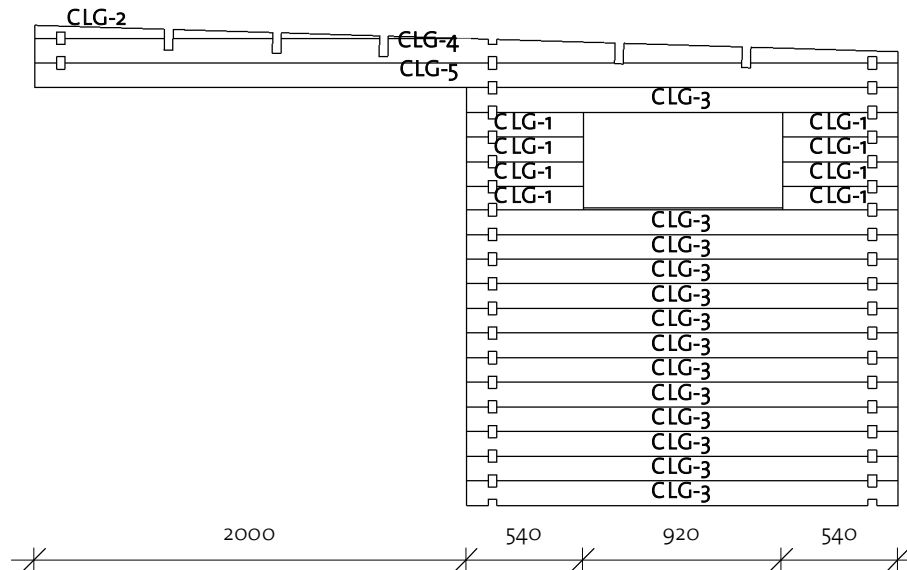

Log Profile Wall C	
Profile	Profile

40x114	
--------	---------------------------------------------------------------------------------------

Miami 40 (480x380)

Roof 1

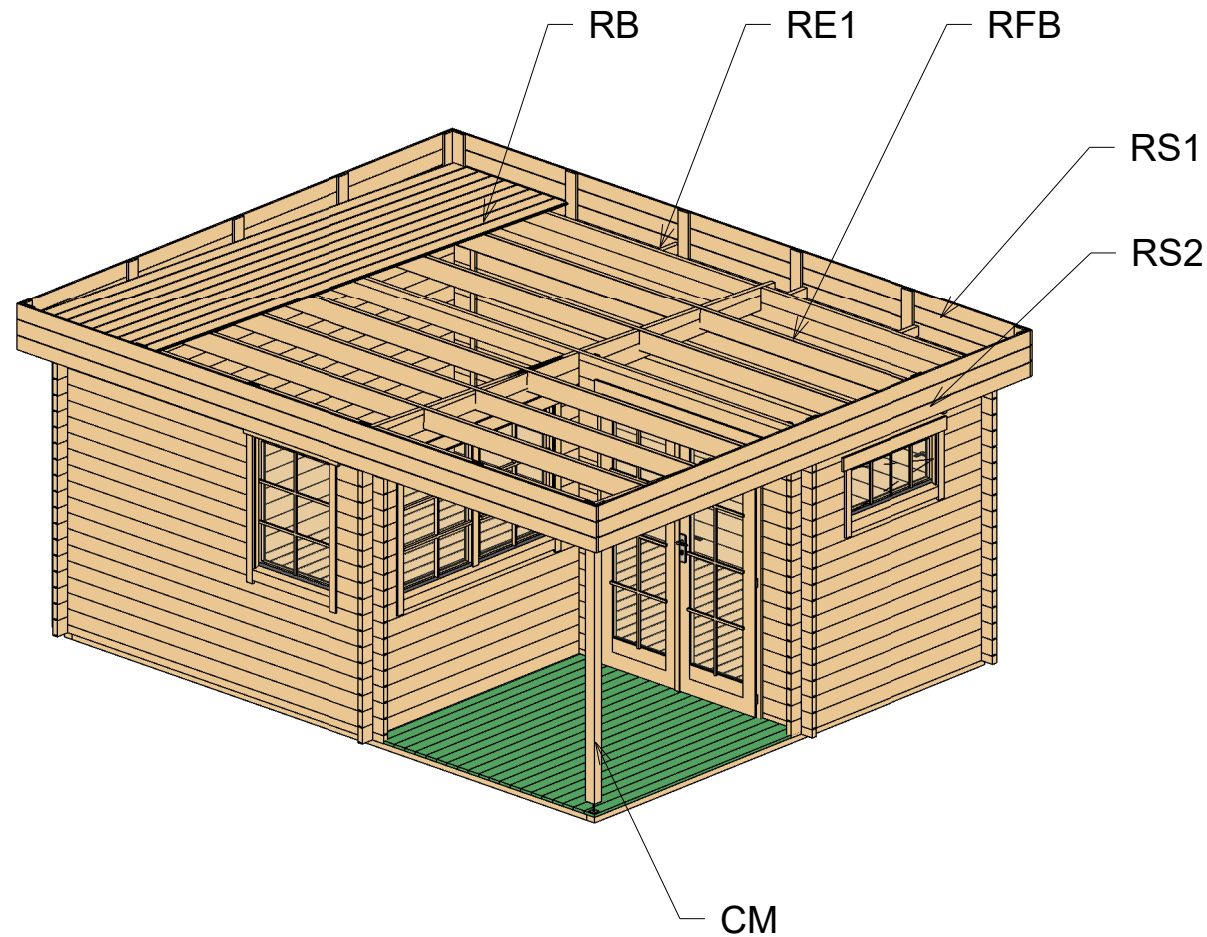

Roof				
Mark	Type	Profile	Count	Length

RB	17x114		47	4152
RE1	40x70		8	200
RFB	Beam 40x143		5	5200

Columns			
Mark	Profile	Count	Length

CM	Post 80x70	1	1899
----	------------	---	------

Roof Side Schedule		
Type	Length	Count

RS1	5234	2
RS2	4200	2

Miami 40 (480x380)

Roof 2

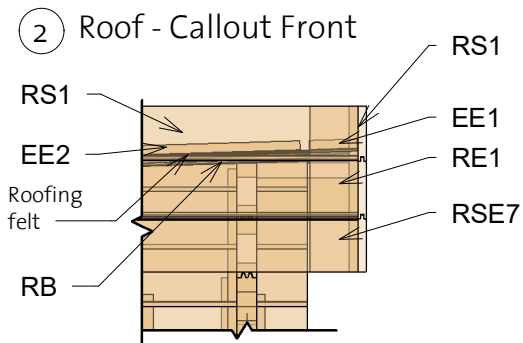
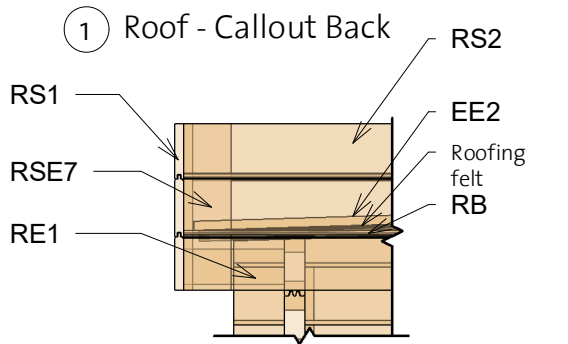
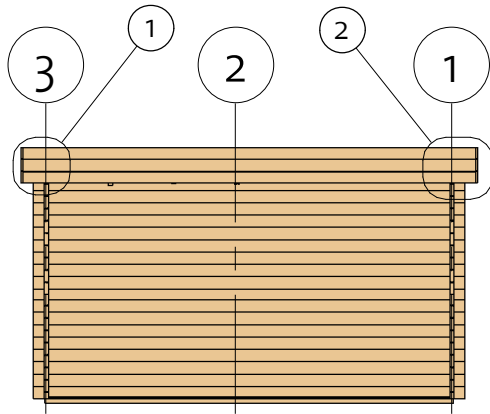

Fascia Schedule				
Mark	Type	Profile	Count	Length
EE1	Eave Edging 18x95		1	5164
EE2	Eave Edging 18x95		2	4067

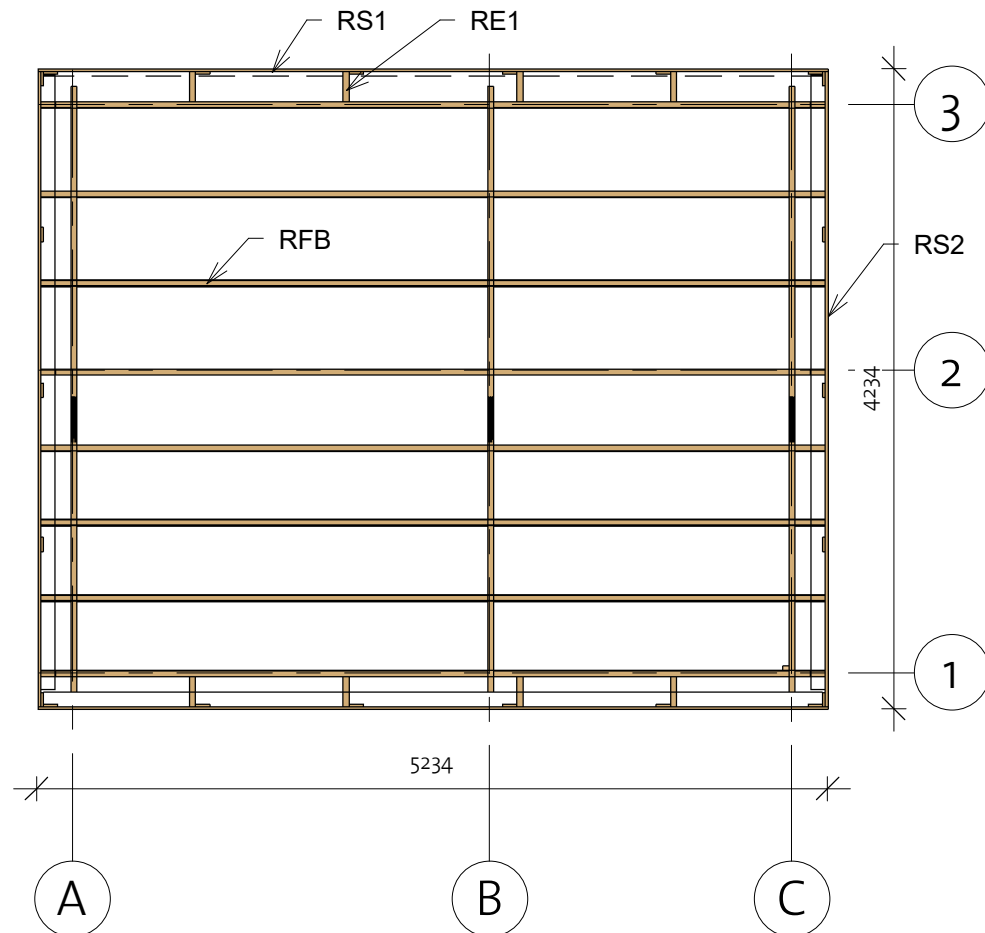

Miami 40 (480x380)

Extras

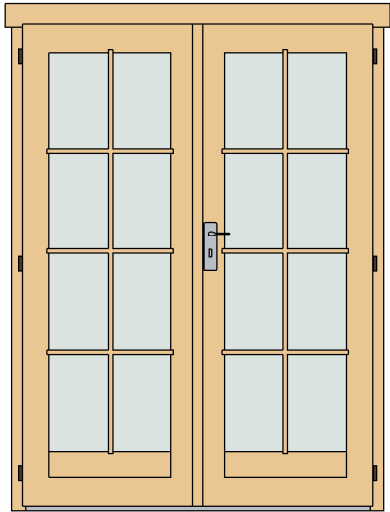

Door Schedule				
Mark	Type	Width	Height	Count
CDD3R	Classic double door 3 right	1425	1955	1
DB	Door beam 1440 mm	40	12	1
DCB8	Door Crossbar 8	--	--	2

Window Schedule				
Mark	Type	Width	Height	Count
CDW1	Classic double window 1	1530	990	1
CW1R	Classic window 1 right	765	990	1
CW5R	Classic window 5 right	915	420	1

Fasteners & Extras		
Name	Type	Count

Hitblock	300-400 mm	
Adjustable post foot		1
Bolts	M8 x 70	18
Screws	5,0 x 70	40
Nails	1,4 x 40	45
Screws	6,0 x 140	65
Screws	4,0 x 40	1010

Type	Count	Length
------	-------	--------

Windboard 18x40	6	2200
-----------------	---	------

WCB6	Windows Crossbar 6	--	--	4
------	--------------------	----	----	---

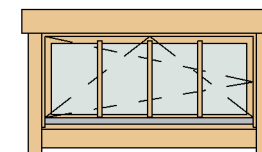
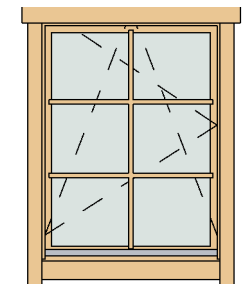
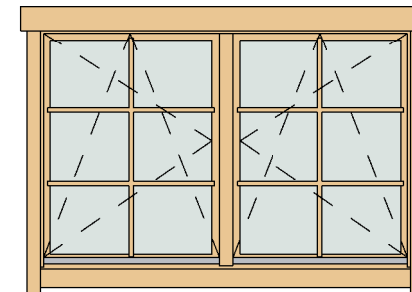

* CW5R intended for tilt opening only!



Miami 40 (480x380)

List of all items 1



Impregnated foundation beams

Mark	Type	Profile	Count	Length
IFB1	IFB 70x40		8	4650
IFB2	IFB 70x40		2	3790
IFB3	IFB 70x40		1	2065



Fascia Schedule

Mark	Type	Profile	Count	Length
EE1	Eave Edging 18x95		1	5164
EE2	Eave Edging 18x95		2	4067

Roof

Mark	Type	Profile	Count	Length
RB	17x114		47	4152
RE1	40x70		8	200
RFB	Beam 40x143		5	5200

Floor Schedule

Mark	Type	Profile	Count	Length
FB1	FB 17x114		18	1749
FB2	FB 17x114		26	3714
TB	TB 21x95		21	1995

BB	BB 20x40		4	4800
----	-------------	-------------------------------------------------------------------------------------	---	------

Columns

Mark	Profile	Count	Length
CM	Post 80x70	1	1899

Roof Side Schedule

Type	Length	Count
RS1	5234	2
RS2	4200	2

Miami 40 (480x380)

List of all items 2

Wall 1			
Mark	Profile	Count	Cut Length

1BL-1	40X57	1	3000
1LG-1	40X114	8	440
1LG-2	40X114	8	1785
1LG-3	40X114	7	3000
1LG-4	40X114	1	5000
1LG-5	40X114	1	3000
1LG-6	40X114	1	3000
1TL-1	40X114	1	5200

Wall 2			
Mark	Profile	Count	Cut Length

2BL-1	40X57	1	338
2BL-2	40X57	1	463
2LG-1	40X114	17	338
2LG-2	40X114	1	5200
2LG-3	40X114	17	463
2TL-1	40X53	1	5200

Wall 3			
Mark	Profile	Count	Cut Length

3BL-1	40X57	1	5000
3LG-1	40X114	16	5000
3LG-2	40X114	1	5000
3TL-1	40X114	1	5200

Wall A			
Mark	Profile	Count	Cut Length

ALG-1	40X114	17	4000
ALG-2*	40X114	1	4000
ALG-3*	40X114	1	4000
ALG-4*	40X114	1	1957

Wall B			
Mark	Profile	Count	Cut Length



BLG-1	40X114	18	350
BLG-2*	40X114	1	1957
BLG-3	40X114	8	2240
BLG-4*	40X114	1	4000
BLG-5*	40X114	1	4000

Wall C			
Mark	Profile	Count	Cut Length

CLG-1	40X114	8	540
CLG-2*	40X114	1	1957
CLG-3	40X114	13	2000
CLG-4*	40X114	1	4000
CLG-5*	40X114	1	4000

* Gable - delivered premounted

Log Profiles	
Profile	Profile

40X114	
40X114	
40X53	
40X57	